

Strip Heaters

Mica Strip

The Watlow mica strip heater is an economical and reliable source of heat for industrial equipment. A mere 15 mils (0.4 mm) thick mica insulator on both sides of the resistance element provides complete electrical insulation and offers little resistance to efficient heat flow. Plus mica withstands high voltage spikes, resists moisture and is inert to most chemicals.

Performance Capabilities

- Sheath temperatures to 480°C (900°F) on zinc-coated units
- Sheath temperatures of 650°C (1200°F) on stainless steel units
- Watt densities to 55 W/in² (8.5 W/cm²)
- Maximum voltage 480V~(ac)

Features and Benefits

Low mass construction

- Heats up faster to provide quick response to control output

Flat resistance ribbon

- Generates heat over a broad area
- Puts the heat source closer to the work

Rust resistant, zinc-coated steel sheath is treated to improve emissivity

- Gives the heater rigidity

Optional stainless steel sheath

- Available for more corrosive atmospheres

Nickel-plated steel terminal posts are securely riveted

- Ensures a positive, trouble-free connection to the resistance circuit

Computer-aided design engineering

- Assures the best combination of ribbon gauge, total wattage and winding spacing
- Maximizes heat transfer and life of heater

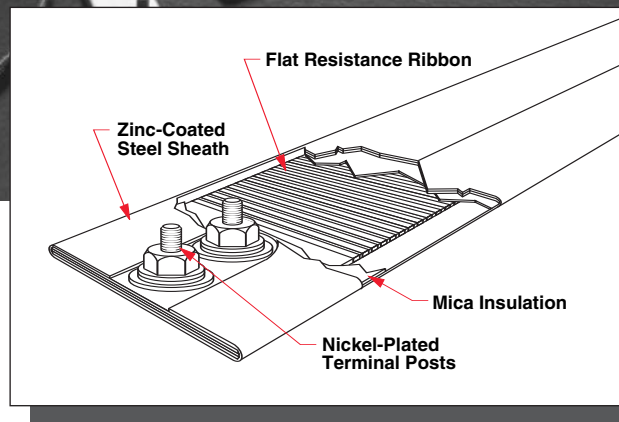
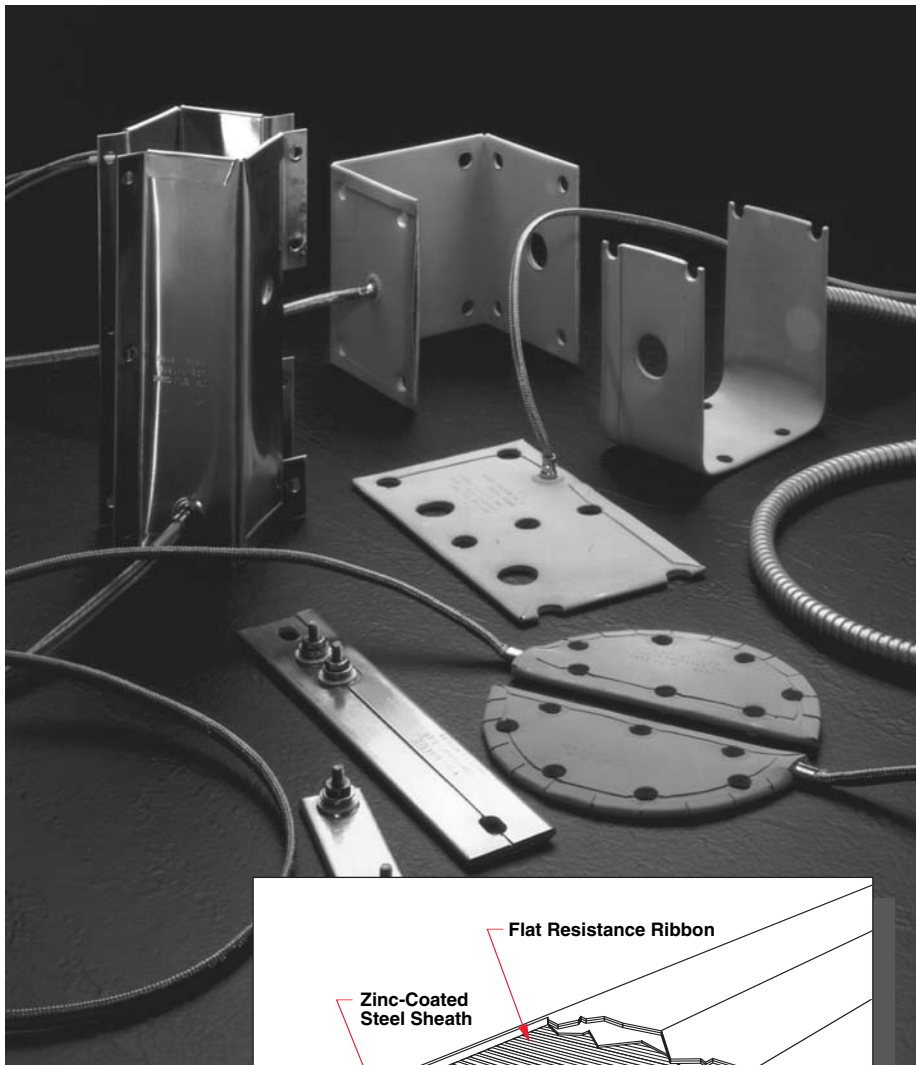

All incoming mica receives a quality control inspection

- Guarantees excellent dielectric strength

UL® component recognition

- Available for applications to 480°C (900°F) sheath temperature

Applications

- Vulcanizing presses
- Sealing equipment
- Hot plates
- Hot stamping
- Dies and molds
- Thermoforming
- Tin melting
- Packaging equipment
- Food warming equipment

Strip Heaters

Mica Strip

Applications and Technical Data

Type 1—Opposite Ends



Type 2—Tandem

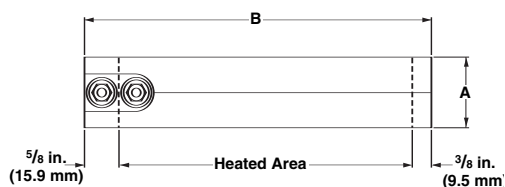

Type 3—Parallel Made-to-Order



Type 4—Opposite Ends with Holes

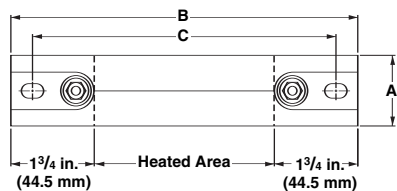

Type 5—Tandem with Holes

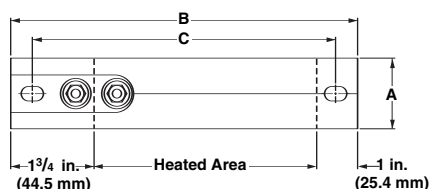

Type 6—Parallel with Holes

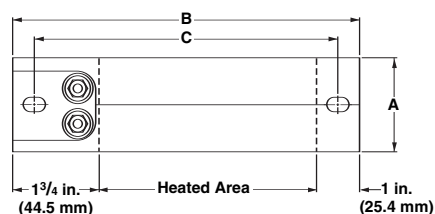

Specify **Type** when ordering.

Physical Limitations of Lead Variations

Heater Type	Width		Length	
	Minimum in. (mm)	Maximum in. (mm)	Minimum in. (mm)	Maximum in. (mm)
Post Terminal				
Type 1 - Opposite ends	5/8 (15.8)	15 (381)	2 (50.8)	96 ^① (2438.4)
Type 2 - Tandem	5/8 (15.8)	15 (381)	2 (50.8)	96 ^① (2438.4)
Type 3 - Parallel	1 1/2 (38.1)	15 (381)	2 (50.8)	96 ^① (2438.4)
Type 4 - Opposite ends with holes	5/8 (15.8)	15 (381)	5 1/2 (139.7)	96 ^① (2438.4)
Type 5 - Tandem with holes	5/8 (15.8)	15 (381)	5 1/2 (139.7)	96 ^① (2438.4)
Type 6 - Parallel with holes	1 1/2 (38.1)	15 (381)	5 1/2 (139.7)	96 ^① (2438.4)
Leads				
Type C, E, F, H	1 (25.4)	15 (381)	5 1/2 (139.7)	96 ^① (2438.4)
Type K				
without mounting holes	1 (25.4)	15 (381)	5 1/2 (139.7)	96 ^① (2438.4)
with mounting holes	1 1/2 (38.1)	15 (381)	5 1/2 (139.7)	96 ^① (2438.4)
European Plug				
Vertical	1 (25.4)	15 (381)	5 1/2 (139.7)	96 ^① (2438.4)
Horizontal	2 1/2 (63.5)	15 (381)	6 1/4 (159)	96 ^① (2438.4)
Three Phase	3 (76.2)	15 (381)	5 1/2 (139.7)	96 ^① (2438.4)
Dual Voltage	3 (76.2)	15 (381)	5 1/2 (139.7)	96 ^① (2438.4)
Terminal Box ^②				
Type 2 - Tandem	1 1/2 (38.1)	15 (381)	4 1/4 (108)	96 ^① (2438.4)
Type 3 - Parallel	2 1/2 (63.5)	15 (381)	4 1/4 (108)	96 ^① (2438.4)
Type 5 - Tandem with holes	1 1/2 (38.1)	15 (381)	6 1/4 (159)	96 ^① (2438.4)
Type 6 - Parallel with holes	2 1/2 (63.5)	15 (381)	6 1/4 (159)	96 ^① (2438.4)

① Consult the factory if you need to exceed 96 inches (2438.4 mm).

② Not available on stock heaters.

Note: Some combinations of maximum and minimums cannot occur on the same heater.

Terminations

Types 1 through 6, as illustrated, show the placement of terminals for Watlow mica strip heaters. However, please note Type 3 terminals are not available on stock units. Placement is specified in terms of length, width and center-to-center dimensions. These dimensions are as follows:

Length:

Tolerance: $\pm 1/16$ inch (1.6 mm)

Width:

Tolerance: $\pm 1/16$ inch (1.6 mm)

Thickness:

Nominal: $3/16$ inch (4.7 mm)

Types 4, 5 and 6 have $3/8$ inch x $1/4$ inch (9.5 mm x 6.3 mm) mounting slots. Letters A, B and C, called out in the illustrations, denote the following: A = width, B = overall length and C = center-to-center dimensions on mounting slots.

Strip Heaters

Mica Strip

Applications and Technical Data

Continued

Calculating Watt Density

Watt density is the amount of wattage per square inch of heated area. To determine watt density, divide the total wattage by the heated area.

$$\text{Watt Density} = \frac{\text{Total Watts}}{\text{Heated Area}}$$

To apply this equation, we must define the term “heated area.” Heated area is the total contact surface of the heater less areas of no heat that are found around terminals, mounting holes, etc.

$$\text{Heated Area} = \text{Total Contact Area} - \text{No-Heat Area}$$

To calculate the heated area:

$$\text{Heated Area} = (\text{Length} - \text{No-Heat Area}) \times \text{Width}$$

Maximum Allowable Watt Density

The following derating factors are applicable to the **Maximum Allowable Watt Density** graph. Please review these factors and the graph to determine the maximum watt density for the application.

Derating Factors:

- For heaters mounted less than one inch (25 mm) apart on a metal part, derate by five percent.
- For heaters mounted within three inches (76 mm) of a reflective surface, derate by 10 percent.
- For heaters mounted two to six inches (51 to 150 mm) apart and radiating toward each other, derate by 10 percent.
- For heaters mounted within one inch (25 mm) of a reflective surface, derate by 20 percent.
- For heaters mounted less than two inches (51 mm) apart and radiating toward each other, derate by 20 percent.
- For termination Types 2 and 5, as well as lead Types C, E and H (see illustrations on pages 234 and 236) that are less than two inches (51 mm) wide, derate as follows: zinc-coated units by 10 percent and stainless steel units by 20 percent.

Application Hints

To maximize the performance of a mica strip heater, ensure:

- Small heaters with 5 in² (32.3 cm²) or less of heated area are 120V~(ac). These heaters can be wired in series for a 240V~(ac) power supply.
- The surface to be heated is clean and smooth, so that heat is transferred efficiently. Even small air gaps can cause hot spotting.
- Terminal post nuts are not overly tightened. Although the posts are securely riveted to the elements, excessive torque could break the connection.

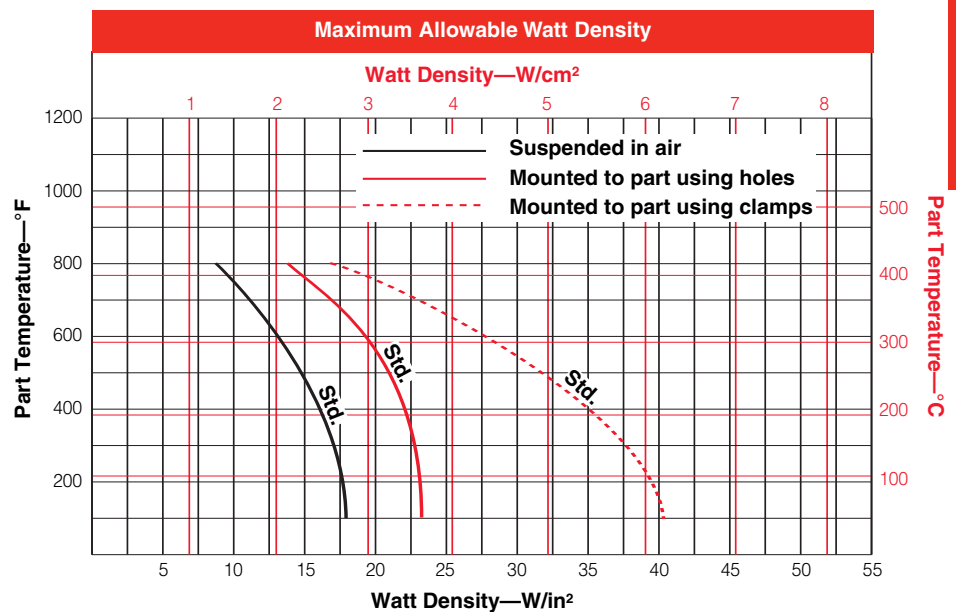

Strip Heaters

Mica Strip

Termination Options

Post Terminals (Standard)

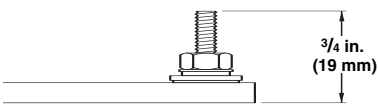

Post terminals have a threaded length of $\frac{7}{16}$ inch (11 mm) and require approximately $\frac{3}{4}$ inch (19 mm) clearance. Specify **standard terminals** when ordering.

Long Terminals

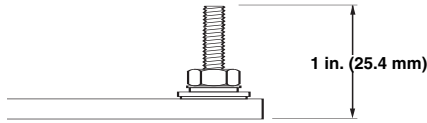

Longer terminals with $\frac{1}{16}$ inch (17.5 mm) threaded lengths are available and require approximately one inch (25 mm) clearance. Specify **long terminals** when ordering.

Button Terminals

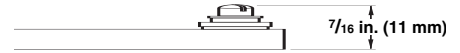

The slotted screw head terminals require only $\frac{7}{16}$ inch (11 mm) clearance. Specify **button terminals** when ordering.

Three Terminal Construction

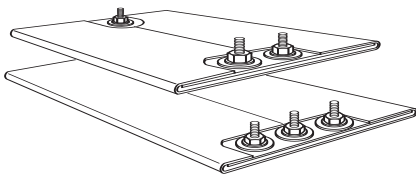

A third terminal can be added to provide dual voltage or three-heat operation. Or, it can be connected to the sheath for easy grounding. Specify **dual voltage** or **three-heat operation** when ordering.

Type E—Loose Metal Braided Leads Type C—Metal Overbraid Leads

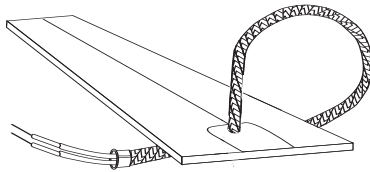

Loose metal braid encloses two fiberglass leads for good abrasion protection, lead flexibility and wiring convenience. Leads are two inches (51 mm) longer than the braid. To order, specify **Type E** and **length**.

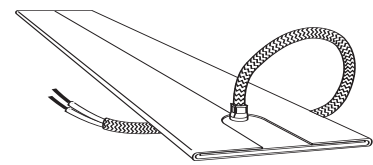

Each fiberglass-insulated lead wire exits in a single metal braid from the back of the heater. This arrangement offers abrasion protection, lead flexibility and convenient wiring for a neat installation. Minimum heater length is $5\frac{1}{2}$ inches (140 mm). Specify **Type C** and **length** when ordering. Leads are two inches longer than braid.

Type H—Flexible Steel Hose Leads (Vertical)

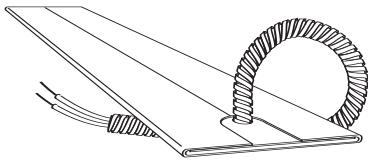

Galvanized, flexible steel hose gives superior mechanical protection where lead abrasion is a particular problem. Minimum heater length is $5\frac{1}{2}$ inches (140 mm). Specify **Type H** and **lead length** when ordering. Leads are typically two inches longer than hose.

Type K—Flexible Leads

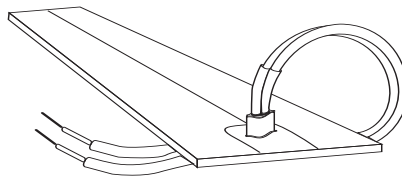

Two on One (Vertical)

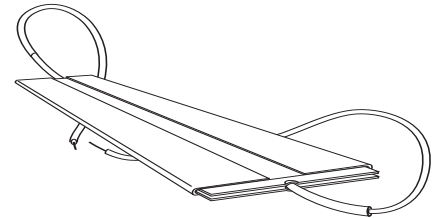

One on One (Horizontal)

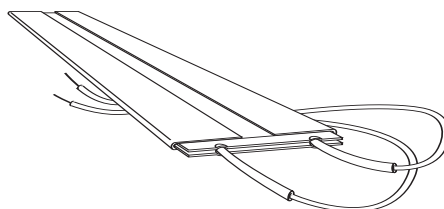

Two on One (Horizontal)

Type K has two fiberglass-insulated leads. These leads can exit one at each end or both at the same end, so please specify end termination when ordering. Type K is suitable for applications where lead abrasion is not a problem. Specify **Type K orientation** and **length** when ordering.

Strip Heaters

Mica Strip

Options

External Finishing

Sheath Material

Please specify a stainless steel sheath when the part temperature reaches in excess of 370°C (700°F).

Holes or Slots

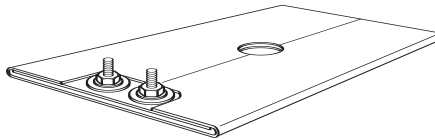

When required for instrumentation or mounting, holes or slots may be provided as a manufactured variation in nearly any location as long as there is at least one inch (25 mm) between the edge of the hole and one side of the heater. Dimensional drawing is required when ordering.

Widths

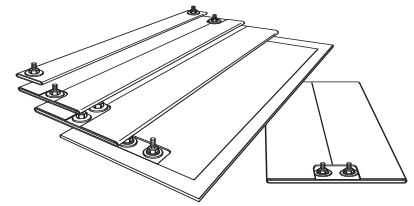

The 1½ inch (38 mm) wide heater is the most efficient size due to its maximum clamping effect. Heaters are available in widths from ¾ inch (16 mm) to 24 inches (610 mm).

Heaters five inches (125 mm) wide and greater are constructed with end folds and a reinforcement shim rather than full folds. Units less than 1¼ inches (35 mm) wide have the sheath seam on the side opposite the terminals.

Open Element



This economical heater design without the metal case is commonly used in laminating machines. The heater assembly is sandwiched between machine parts, eliminating the need for additional and expensive metal cases.

Distributed Wattage



A mica strip heater can be designed with varying heat profile along the length for uneven heat distribution.

Butt Case

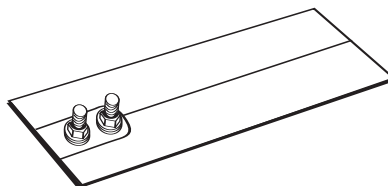

Recommended for heating applications where strip heater will be placed in a milled slot between two steel plates. Specify **butt case** construction when ordering.

Four Sides Closed

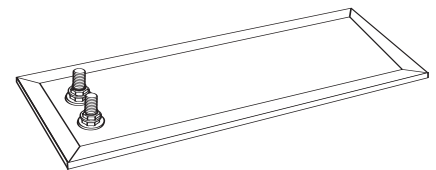

Mica strip heaters can be closed on all four sides to prevent contamination from getting inside the heater. Standard on strip heaters five inches wide and greater.

Strip Heaters

Mica Strip

Options

External Finishing

Ring Heaters

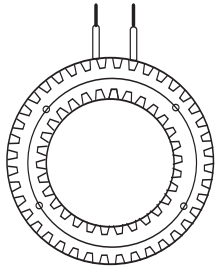

When ordering ring heaters, specify **inside** and **outside diameters**. If mounting holes are required, specify location and hole size.

Irregular Shapes

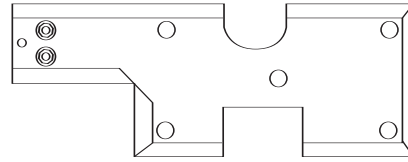

Mica strip heaters can be made into any practical shape and electrical rating. Examples include: cone, flat circular, square, rectangular and hexagon.

Cross Section Formed

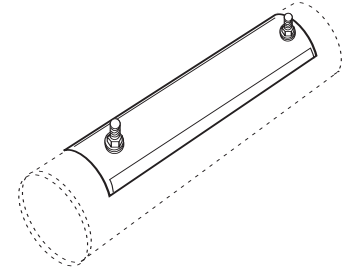

Strip heaters can be formed on a cross section for piping applications. Specify diameter of pipe on which heaters are to be mounted.

Square, Rectangular Bands

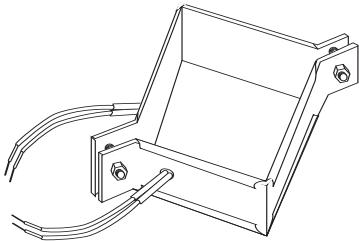

Square or rectangular heaters are normally used for heating dies on plastic extruders, or the barrels of twin screw extruders. These can be made in either one or two piece construction (see illustrations).

Clamping Styles

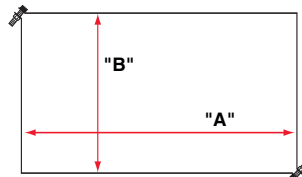

Figure 1

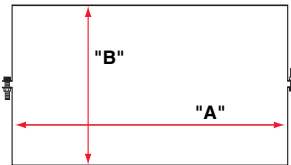

Figure 2

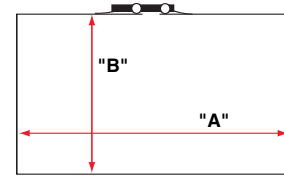
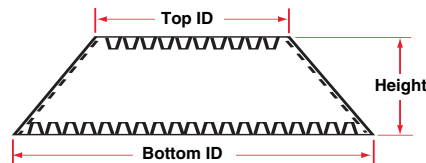

Figure 3

Referring to the illustrations, the preferred design is Figure 1 with bent-up flange clamping due to the uniform applied clamping force at the corners. Next is Figure 2, with bent-up flanges or built-in strapping brackets at the sides. The least preferred design is Figure 3, one-piece heater, due to the lack of uniform applied clamping force.

Cone Shapes



Cone shaped heaters are normally used for special heating applications when heat is required for hoppers or funnels. They are made strictly to customer specifications. The preferred method of attachment is with bent-up flange clamping.

Hex Bands

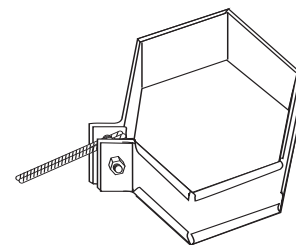

Hex shaped heaters are used on the hex shaped portion of the nozzle on injection molding machines. A drawing is required when ordering.

Strip Heaters

Mica Strip Options

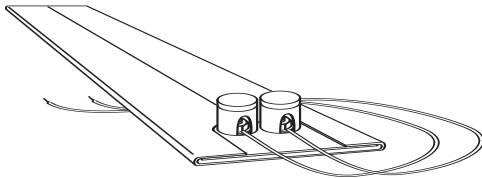

Ceramic Terminal Covers

Ceramic terminal covers are a convenient, economical way to provide safety. Covers are sized for standard $\frac{7}{16}$ inch (11 mm) long post terminals, that require approximately $\frac{3}{4}$ inch (19 mm) clearance.

The clearance, with ceramic cover cap, is 0.91 inch (23.1 mm). Excluding the thickness of the heater, the clearance is 0.75 inch (19 mm). Screw thread size is 10-24. To order, specify Watlow code number **Z-4918** and quantity.

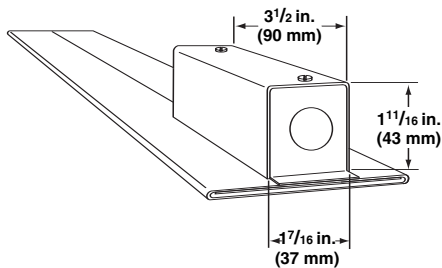

Metallic Terminal Box

A high quality metallic terminal box is welded to the heater sheath. Units with tandem terminals must be at least $1\frac{1}{2}$ inches (38 mm) wide. Units with parallel terminals must be at

least $4\frac{1}{4}$ inches (108 mm) wide. Minimum length is $4\frac{1}{4}$ inches (108 mm) without mounting holes or $6\frac{1}{4}$ inches (159 mm) with holes. When ordering specify **terminal box**.

Accessories Clamping Variations

Clamping Bars

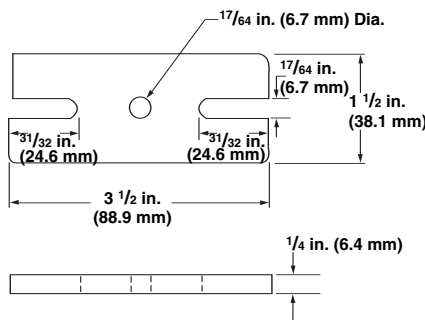

For maximum life and efficient operation, strip heaters must be firmly clamped to the part being heated. Clamping bars $3\frac{1}{2}$ inch (90 mm) wide can be used to clamp strips with a maximum width of three inches (76 mm). Watlow recommends clamping every six inches (150 mm). Specify code number **MB101-1** and quantity when ordering clamping bars.

Strip Heaters

F.O.B.: St. Louis, Missouri

Mica Strip

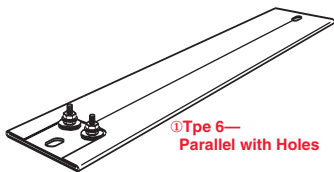
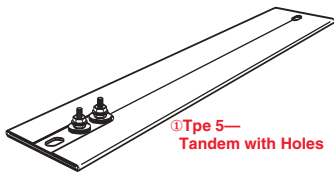
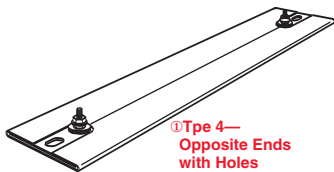
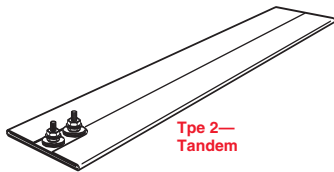
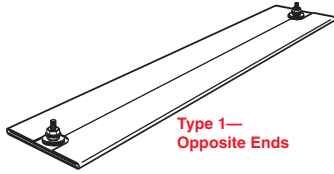

Width in. (mm)	Overall Length in. (mm)	Type	Ctr-to-Ctr Mtg Holes in. (mm)	Volts	Power (Watts)	Watt Density W/in. ² (W/cm ²)	Approx. Net Weight lbs (kg)	Avail.	Code No.
1 (25.4)	3½ (88.9)	1	— —	120	50	22 (3.4)	0.09 (0.04)	Stk	S1A3JP1
	6 (152.4)	1	— —	120	100	21 (3.3)	0.17 (0.08)	Stk	S1A6AP1
	6 (152.4)	1	— —	240	100	21 (3.3)	0.17 (0.08)	Stk	S1A6AP2
	12 (304.8)	4	11 (279.4)	120	175	21 (3.3)	0.33 (0.15)	Stk	S1A12AT1
	12 (304.8)	4	11 (279.4)	240	175	21 (3.3)	0.33 (0.15)	Stk	S1A12AT2
	6 (152.4)	5	5¼ (133.4)	120	100	20 (3.1)	0.17 (0.08)	Stk	S1A6AU1 ②
1½ (38.1)	18 (457.2)	1	— —	120	750	30 (4.6)	0.75 (0.34)	Stk	S1J18AP1
	6 (152.4)	2	— —	120	250	33 (5.1)	0.25 (0.11)	Stk	S1J6AR1
	8 (203.2)	2	— —	120	400	37 (5.7)	0.33 (0.15)	Stk	S1J8AR1
	8 (203.2)	2	— —	240	400	37 (5.7)	0.33 (0.15)	Stk	S1J8AR2
	12 (304.8)	2	— —	120	500	30 (4.6)	0.50 (0.23)	Stk	S1J12AR1
	12 (304.8)	2	— —	240	500	30 (4.6)	0.50 (0.23)	Stk	S1J12AR2
	14 (355.6)	2	— —	120	500	25 (3.9)	0.58 (0.26)	Stk	S1J14AR1
	14 (355.6)	2	— —	240	500	25 (3.9)	0.58 (0.26)	Stk	S1J14AR2
	18 (457.2)	2	— —	120	800	31 (4.8)	0.75 (0.34)	Stk	S1J18AR1
	18 (457.2)	2	— —	240	800	31 (4.8)	0.75 (0.34)	Stk	S1J18AR2
	24 (609.6)	2	— —	120	1000	29 (4.5)	1.0 (0.45)	Stk	S1J24AR1
	24 (609.6)	2	— —	240	1000	29 (4.5)	1.0 (0.45)	Stk	S1J24AR2
	8 (203.2)	4	7 (177.8)	120	150	22 (3.4)	0.33 (0.15)	Stk	S1J8AT1
	12 (304.8)	4	11 (279.4)	120	250	20 (3.1)	0.50 (0.23)	Stk	S1J12AT1
	12 (304.8)	4	11 (279.4)	240	250	20 (3.1)	0.50 (0.23)	Stk	S1J12AT2
	18 (457.2)	4	17 (431.8)	240	500	23 (3.6)	0.75 (0.34)	Stk	S1J18AT1
	5½ (139.7)	5	4½ (114.3)	120	125	30 (4.6)	0.23 (0.11)	Stk	S1J5JU1
	7½ (190.5)	5	6½ (165.1)	120	150	21 (3.3)	0.32 (0.15)	Stk	S1J7JU1
	8 (203.2)	5	7 (177.8)	120	150	19 (2.9)	0.33 (0.15)	Stk	S1J8AU1
	8 (203.2)	5	7 (177.8)	240	150	19 (2.9)	0.33 (0.15)	Stk	S1J8AU2
	8 (203.2)	5	7 (177.8)	120	175	22 (3.4)	0.33 (0.15)	Stk	S1J8AU3
	8 (203.2)	5	7 (177.8)	240	175	22 (3.4)	0.33 (0.15)	Stk	S1J8AU4
	8 (203.2)	5	7 (177.8)	120	250	32 (5.0)	0.33 (0.15)	Stk	S1J8AU5
	8 (203.2)	5	7 (177.8)	240	250	32 (5.0)	0.33 (0.15)	Stk	S1J8AU6
	10 ½ (266.7)	5	9 ½ (241.3)	120	250	22 (3.4)	0.42 (0.19)	Stk	S1J10JU1
	10 ½ (266.7)	5	9 ½ (241.3)	240	250	22 (3.4)	0.42 (0.19)	Stk	S1J10JU2
	12 (304.8)	5	11 (279.4)	120	250	18 (2.8)	0.50 (0.23)	Stk	S1J12AU1
	12 (304.8)	5	11 (279.4)	240	250	18 (2.8)	0.50 (0.23)	Stk	S1J12AU2
	12 (304.8)	5	— —	120	150	11 (1.7)	0.50 (0.23)	Stk	S1J12AU10 ③
	12 (304.8)	5	— —	240	150	11 (1.7)	0.50 (0.23)	Stk	S1J12AU11 ③
15 ¼ (387.4)	5	14 ¼ (362.0)	240	500	27 (4.2)	0.63 (0.29)	Stk	S1J15EU1	
17 ¼ (454.0)	5	16 ¼ (428.6)	120	375	17 (2.6)	0.75 (0.34)	Stk	S1J17RU1	
17 ¼ (454.0)	5	16 ¼ (428.6)	120	500	22 (3.4)	0.75 (0.34)	Stk	S1J17RU2	
17 ¼ (454.0)	5	16 ¼ (428.6)	240	500	22 (3.4)	0.75 (0.34)	Stk	S1J17RU3	
21 (533.4)	5	20 (508.0)	240	650	24 (3.7)	0.87 (0.39)	Stk	S1J21AU1	
23 ¾ (603.3)	5	22 ¾ (577.9)	120	500	16 (2.5)	0.99 (0.45)	Stk	S1J23NU1	
23 ¾ (603.3)	5	22 ¾ (577.9)	240	500	16 (2.5)	0.99 (0.45)	Stk	S1J23NU2	
23 ¾ (603.3)	5	22 ¾ (577.9)	120	750	24 (3.7)	0.99 (0.45)	Stk	S1J23NU3	
23 ¾ (603.3)	5	22 ¾ (577.9)	240	750	24 (3.7)	0.99 (0.45)	Stk	S1J23NU4	
25 ½ (647.7)	5	24 ½ (622.3)	240	650	19 (2.9)	1.10 (0.50)	Stk	S1J25JU1	
30 ½ (774.7)	5	29 ½ (749.3)	240	800	19 (2.9)	1.30 (0.59)	Stk	S1J30JU1	
2 ½ (63.5)	6 ½ (165.1)	6	5 ½ (139.7)	120	225	24 (3.7)	0.45 (0.20)	Stk	S2J6JV1
	6 ½ (165.1)	6	5 ½ (139.7)	240	225	24 (3.7)	0.45 (0.20)	Stk	S2J6JV2
	8 ½ (215.9)	6	7 ½ (190.5)	120	350	24 (3.7)	0.59 (0.27)	Stk	S2J8JV1
	8 ½ (215.9)	6	7 ½ (190.5)	240	350	24 (3.7)	0.59 (0.27)	Stk	S2J8JV2
	25 ½ (647.7)	6	24 ½ (622.3)	120	1000	18 (2.8)	1.78 (0.81)	Stk	S2J25JV1
	25 ½ (647.7)	6	24 ½ (622.3)	240	1000	18 (2.8)	1.78 (0.81)	Stk	S2J25JV2

How to Order

To order stock mica strip heater, specify:

- Quantity
- Watlow code number

Availability

Stock: Same day shipment

Made-to-Order: If stock units do not meet application needs, Watlow can manufacture mica strip heaters to special requirements. Please consult a Watlow sales engineer or authorized distributor.

① Mounting slots on stock heaters are ½ x ¾ inch (12.7 x 7.9 mm). On made-to-order units, mounting slots are ¾ x ¾ inch (9.5 x 6.3 mm).

② This unit has ¾ x ¼ inch (9.5 x 6.3 mm) mounting holes.

③ Heaters with code numbers **S1J12AU10** and **S1J12AU11** have zinc-coated steel sheath. All other heaters have stainless steel sheath.